

目 录

一、运输作业组织与管理模块..... 2

二、仓储与配送作业组织与管理模块..... 34

三、国际物流作业组织与管理模块..... 150

四、 快递物流作业组织与管理模块.....	213
-----------------------	-----

湖南商务职业技术学院物流管理专业学生技能考核题库

一、运输作业组织与管理模块

○

○

○

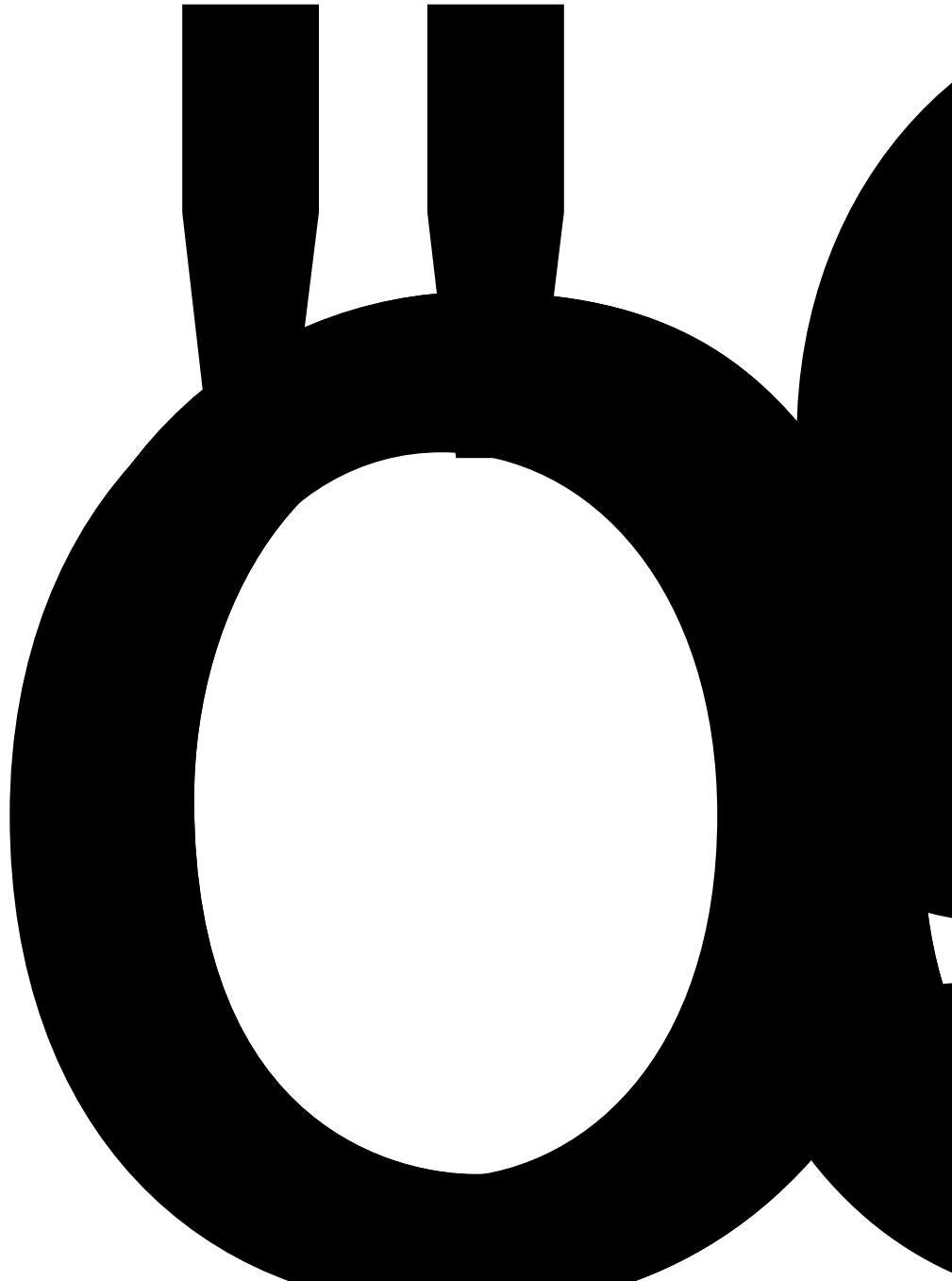

--	--	--

○

○

--	--	--	--	--

() 任务描述

- :
-
-



<input type="checkbox"/> <input type="checkbox"/>				<input type="checkbox"/> <input type="checkbox"/>				
<input type="checkbox"/> <input type="checkbox"/>								
						<input type="checkbox"/> <input type="checkbox"/> <input type="checkbox"/> <input type="checkbox"/>		



() 任务描述:

-
-
-



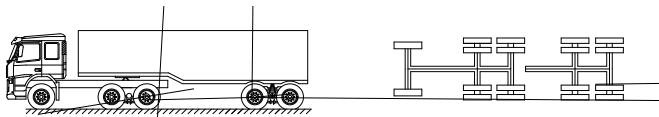
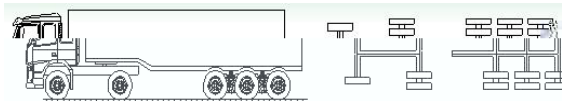

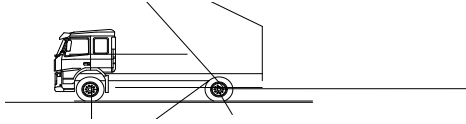
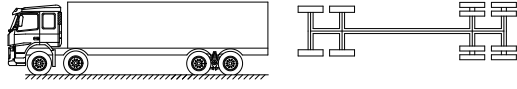
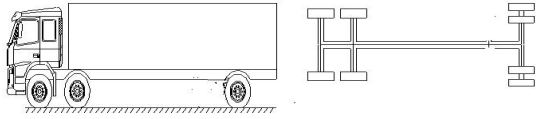

() 任务描述:



○

○

○

○

○

() 任务描述



D

<input type="checkbox"/> <input type="checkbox"/>			<input type="checkbox"/> <input type="checkbox"/>						
<input type="checkbox"/> <input type="checkbox"/>									
						<input type="checkbox"/> <input type="checkbox"/> <input type="checkbox"/> <input type="checkbox"/>			





2

3

4

() 任务描述

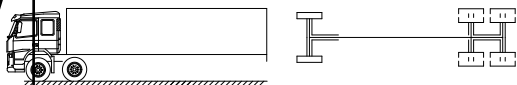
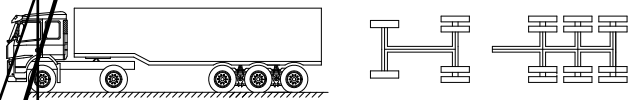
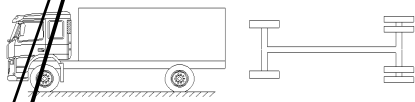
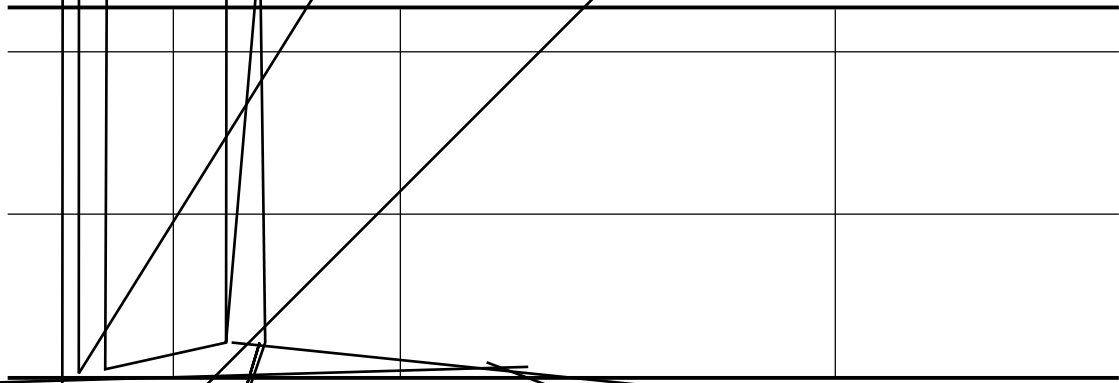



() 任务描述

-
-
-
-
-

() 任务描述

()

()

)	()		

()

()

()

()

()

○

()			

○

Sailing Schedule from : Shenzhen,Shenzhen,Guangdong,China

To : Los Angeles,Los Angeles,CA,United States

Origin City : Shenzhen,Shenzhen,Guangdong,China

Destination City : Los Angeles,Los Angeles,CA,United States

CY/DOOR

CY/DOOR

序列号	航线	船名	航次	截关时间	装货港	预计离港时间	实际离港时间	卸货港
1	YPSW	YM UNISON	59E	2016-04-22 17:00	Yantian	2016-04-25		Los Angeles
2	SEA	NORTHERN JAVELIN	002E	2016-04-23 12:00	Yantian	2016-04-27		Long Beach
3	AAS2	CMA CGM LIBRA	095TXE	2016-04-25 16:00	Yantian	2016-04-28		Long Beach
4	YPSW	YM UBIQUITY	22E	2016-04-29 17:00	Yantian	2016-05-02		Los Angeles
5	SEA	C SCL PUSAN	117E	2016-04-30 12:00	Yantian	2016-05-04		Long Beach
6	AAS2	CMA CGM COLUMBA	097TXE	2016-05-02 16:00	Yantian	2016-05-05		Long Beach
7	SEA	COSCO NINGBO	069W	2016-05-06 11:00	Yantian	2016-05-08		Long Beach
8	YPSW	YM JIREBY	50E	2016-05-06 17:00	Yantian	2016-05-09		Los Angeles
9	SEA	COSCO EXCELLENCE	027E	2016-05-07 12:00	Yantian	2016-05-11		Long Beach
10	AAS2	CMA CGM CENTAURUS	099TXE	2016-05-09 16:00	Yantian	2016-05-12		Long Beach
11	YPSW	YM MASCULINITY	32E	2016-05-13 17:00	Yantian	2016-05-16		Los Angeles
12	SEA	HONG KONG BRIDGE	039E	2016-05-14 12:00	Yantian	2016-05-18		Long Beach
13	AAS2	CMA CGM COLUMBA	097TXE	2016-05-16 16:00	Yantian	2016-05-19		Long Beach



干货箱



	箱体内部尺寸			箱体内容积及载重量		箱门开度尺寸	
	L	W	H	Cu	P	W	H
20'	5898	2352	2393	33.2	21740/28230#	2340	2280
40'	12032	2352	2393	67.7	26630	2340	2280
HC	12032	2352	2698	76.3	26520	2340	2585

冷藏箱



	箱体内部尺寸			箱体内容积及载重量	
	L	W	H	Cu	P
20'	5444	2284	2267	28.5	21135/27160#
40'	11583	2284	2250	58.7	26580
HC	11583	2284	2550	67.3	26520

开顶箱

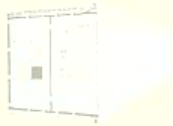

	箱体内部尺寸			箱体内容积及载重量	
	L	W	H	Cu	P
20'	5898	2352	2393	33.2	21740
40'	12032	2352	2393	67.7	26630

○

○

() 实施条件

() 考核时量

() 评分细则

1

() 任务描述



		<input type="checkbox"/>	<input type="checkbox"/>	<input type="checkbox"/>	<input type="checkbox"/>

<input type="checkbox"/>		<input type="checkbox"/>			
<input type="checkbox"/>		<input type="checkbox"/>			



() 实施条件

() 考核时量

() 评分细则

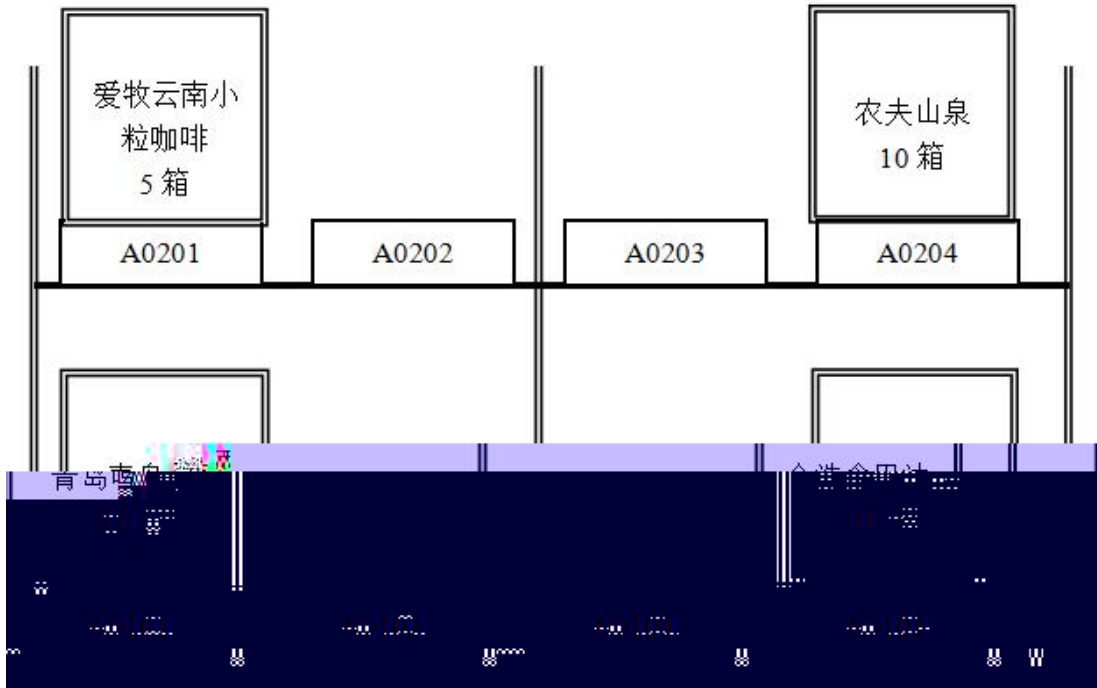

产品运输单

-
-
-
-
-
-
-
-

80				

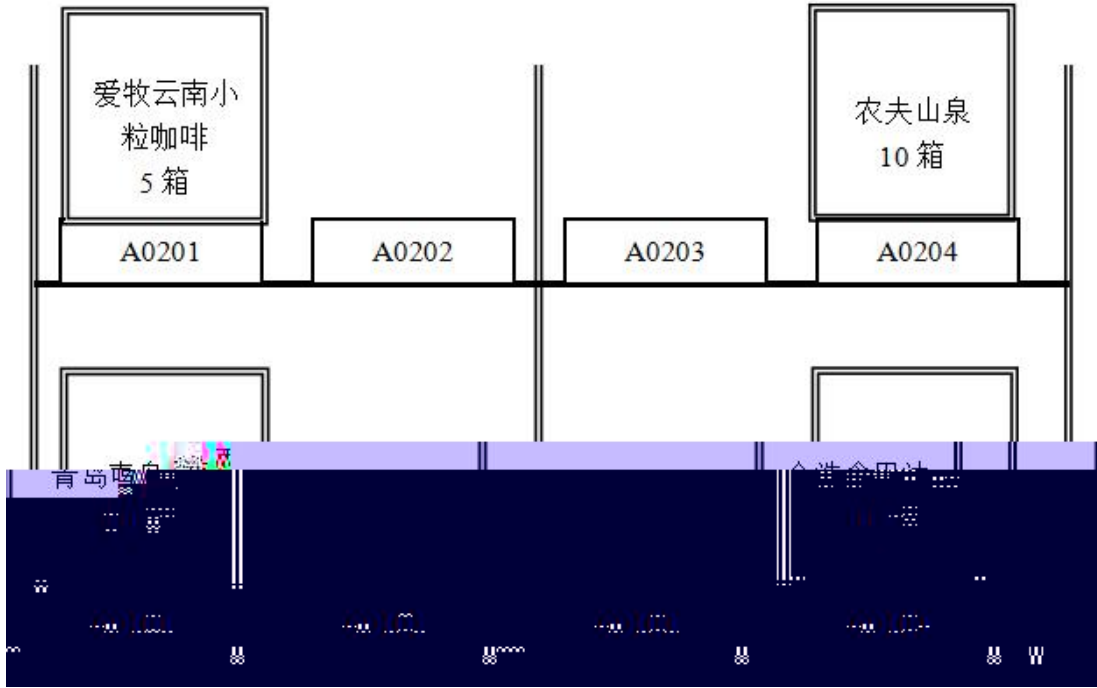

产品运输单

-
-
-
-
-
-
-
-

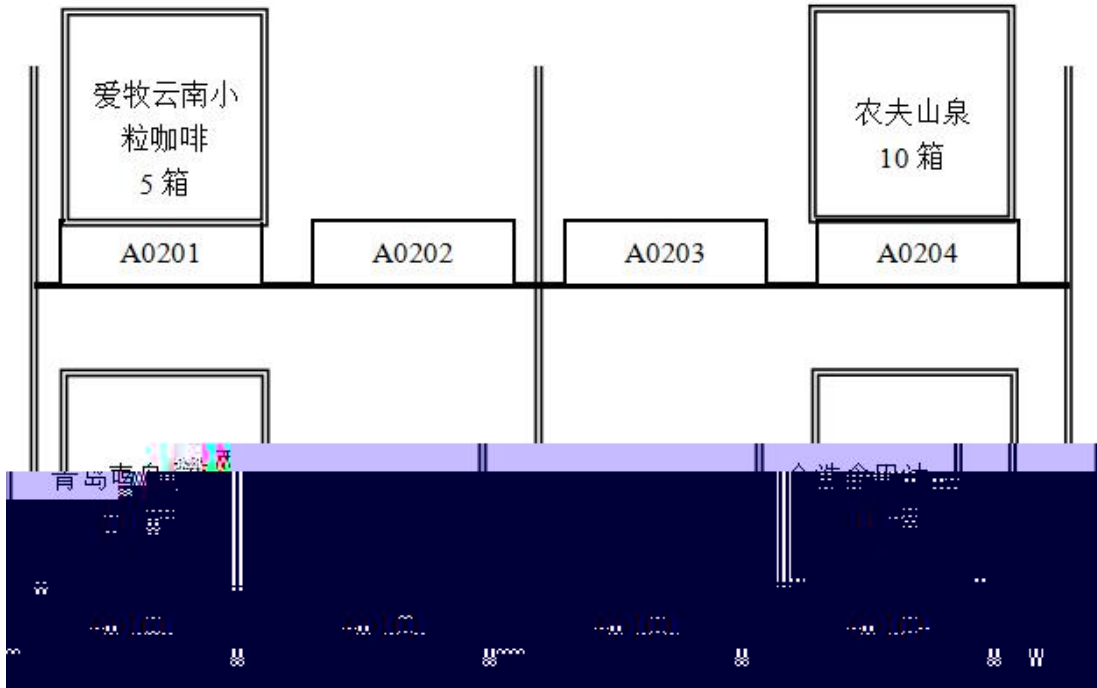

产品运输单

-
-
-
-
-
-
-
-

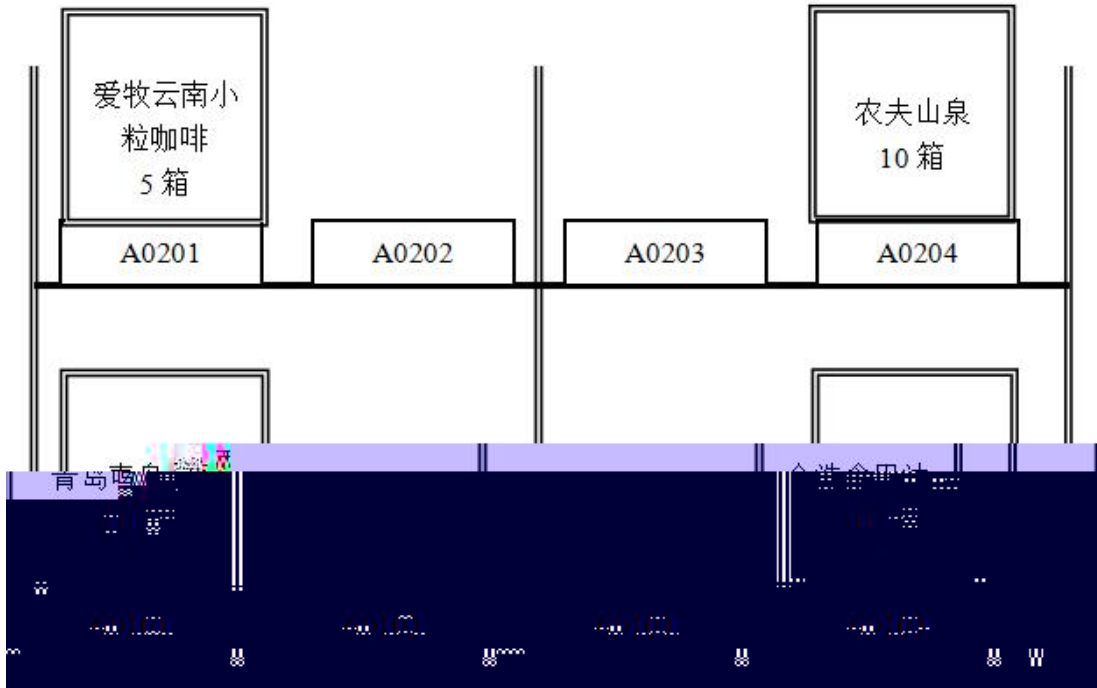

产品运输单

-
-
-
-
-
-
-
-

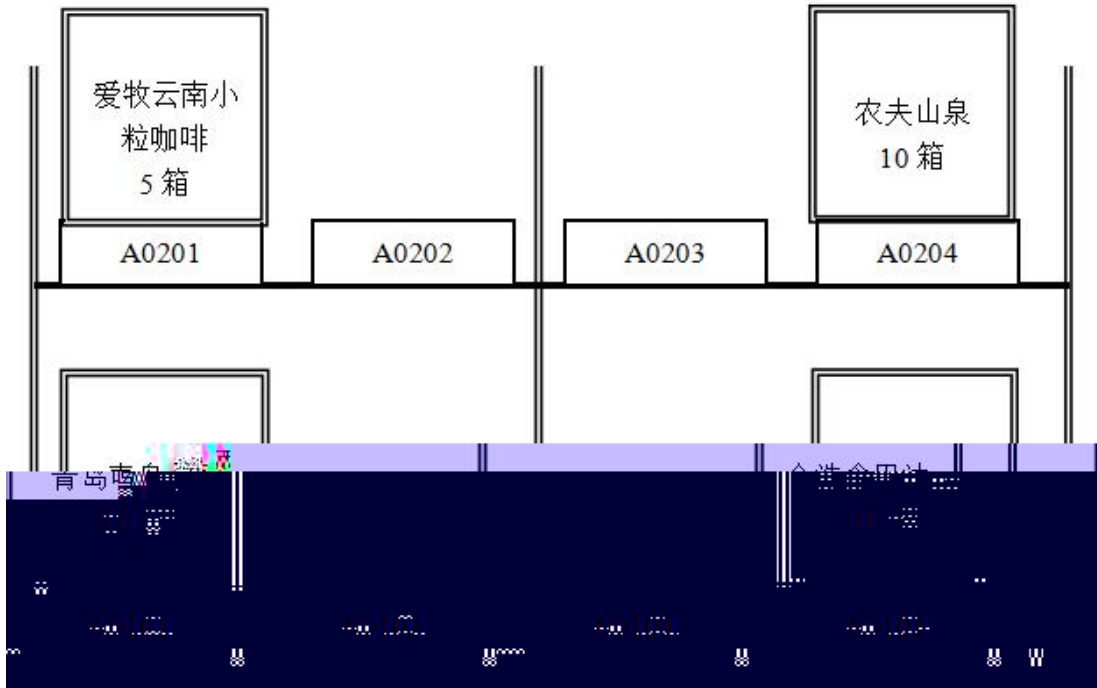

产品运输单

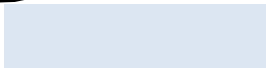

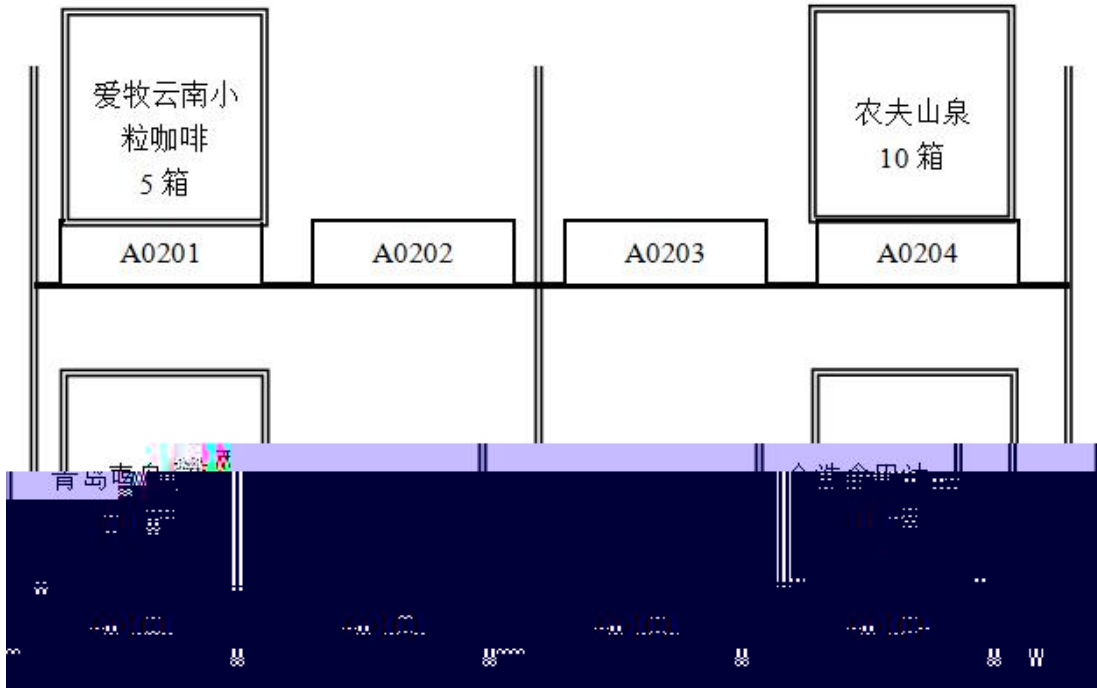

产品运输单

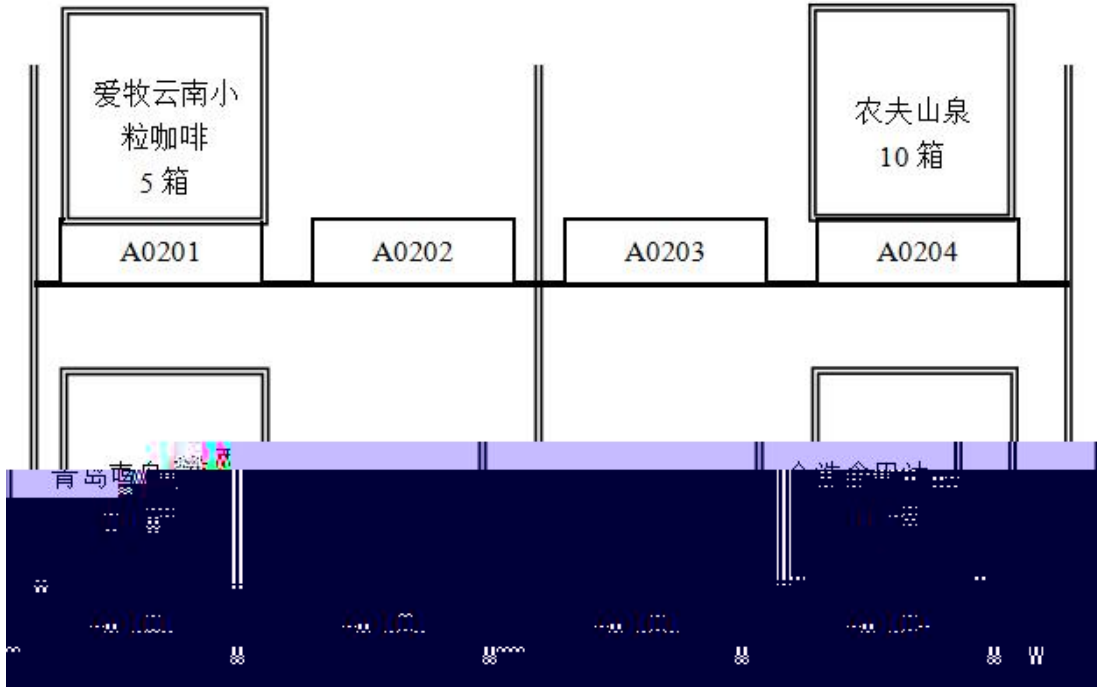

产品运输单

-
-
-
-
-
-
-
-
-

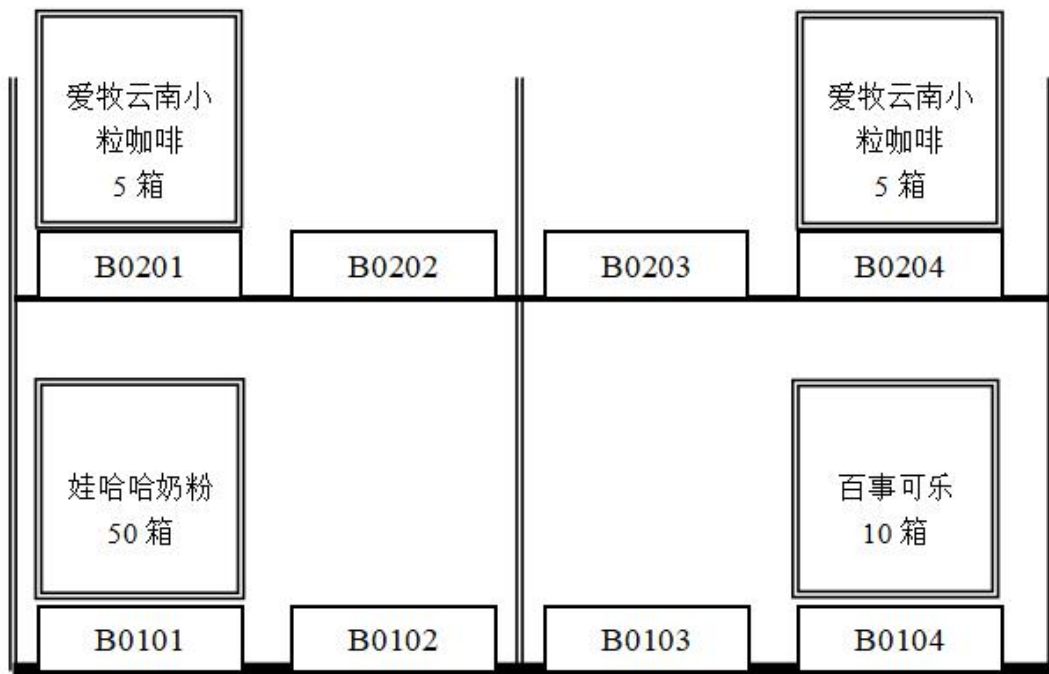
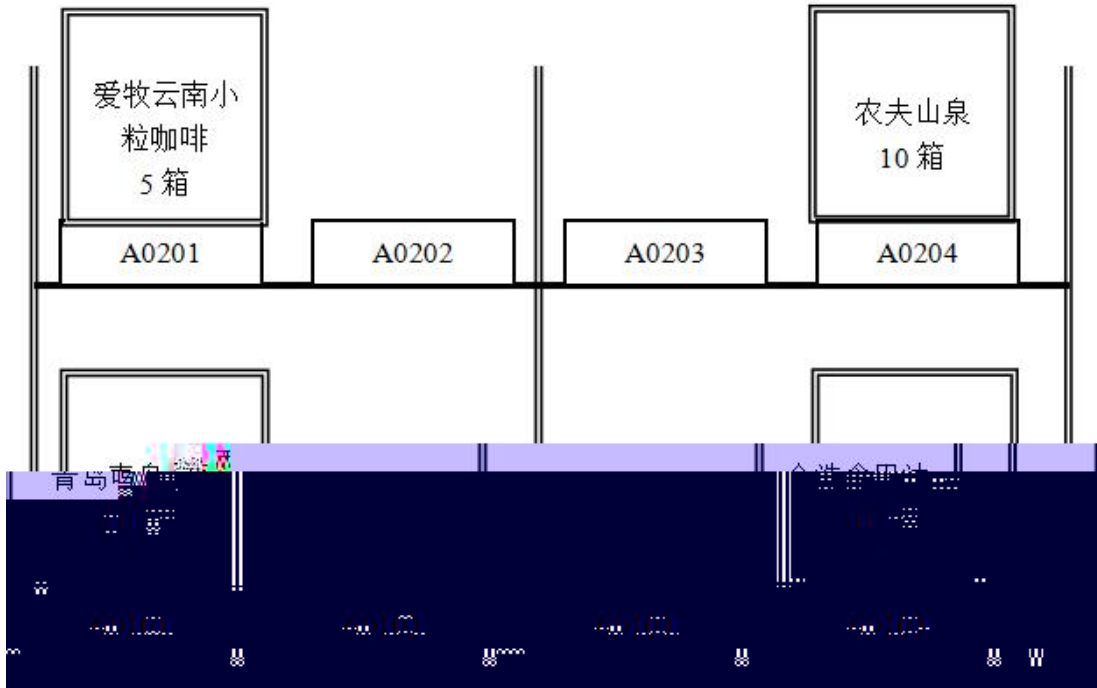

产品运输单

-
-
-
-
-
-
-
-
-

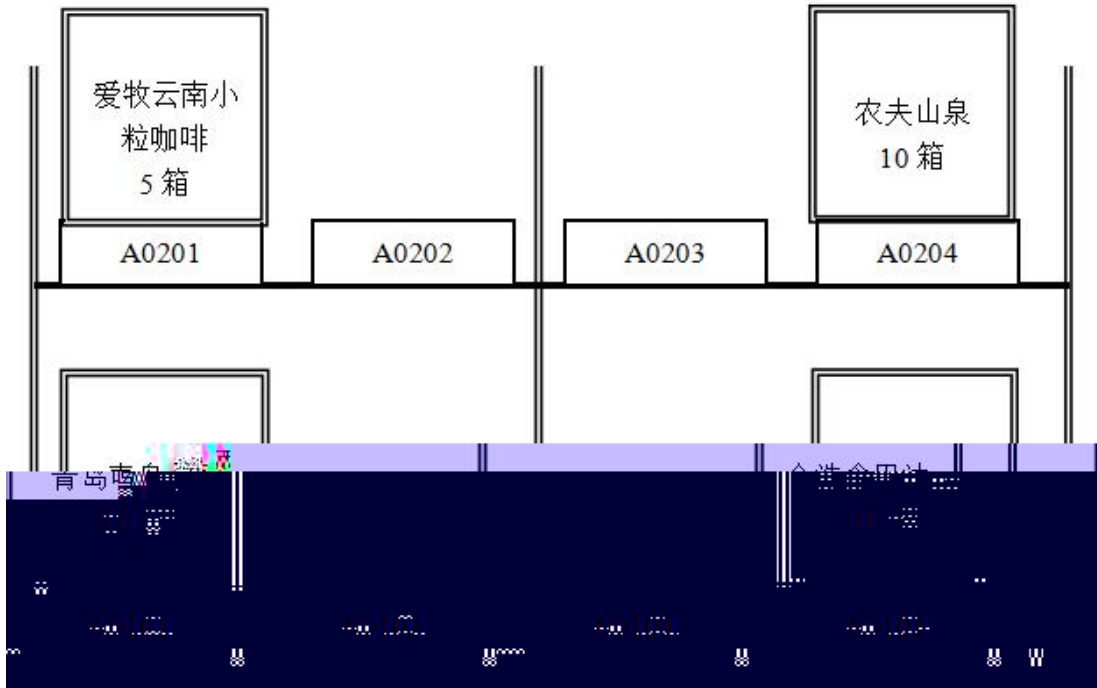

产品运输单

-
-
-
-
-
-
-
-
-

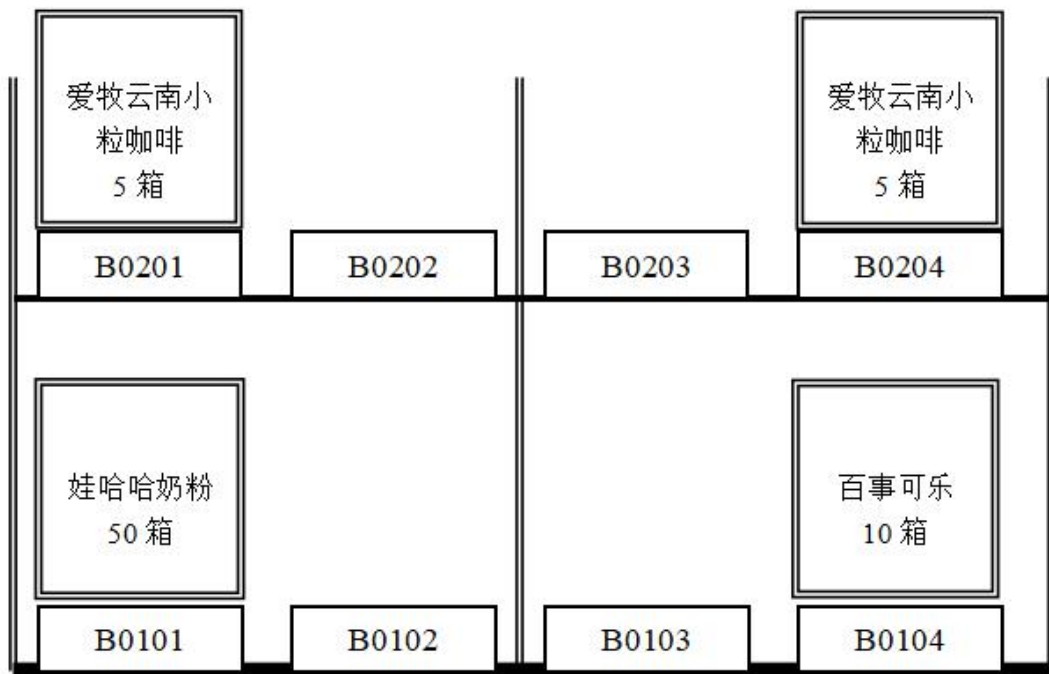
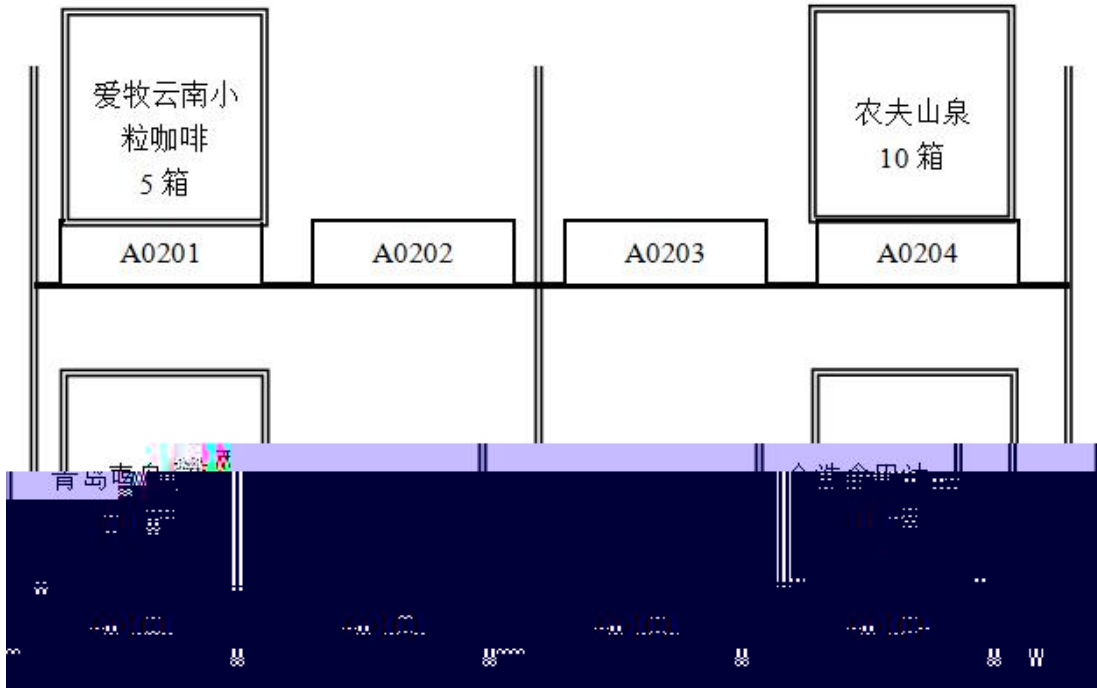

产品运输单

-
-
-
-
-
-
-
-

○

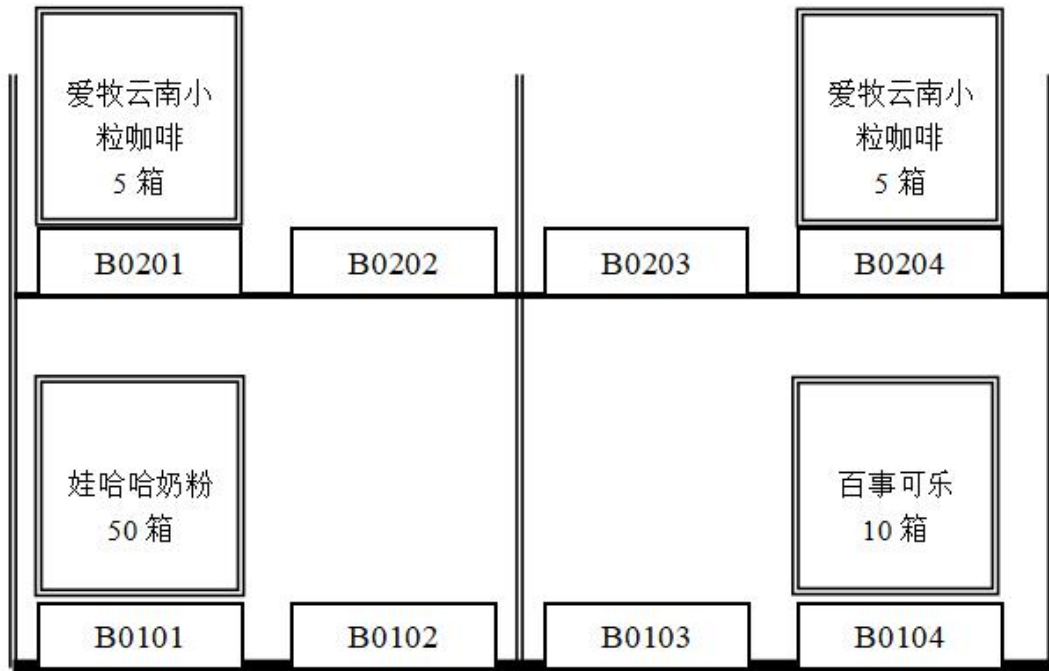
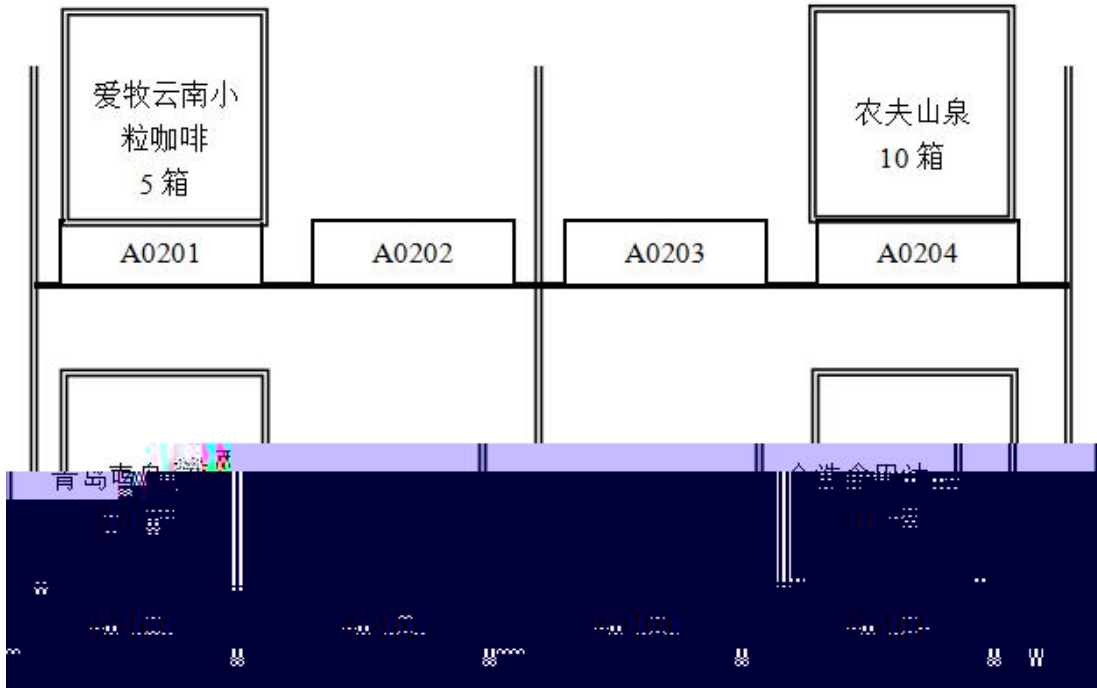

B'



--	--	--	--	--	--

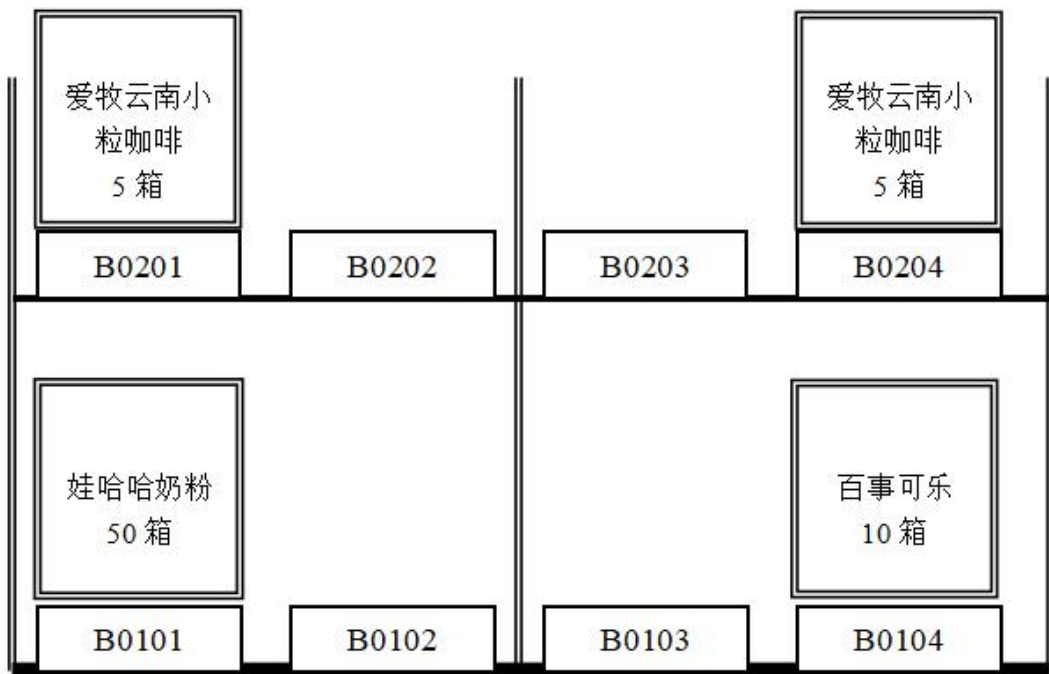
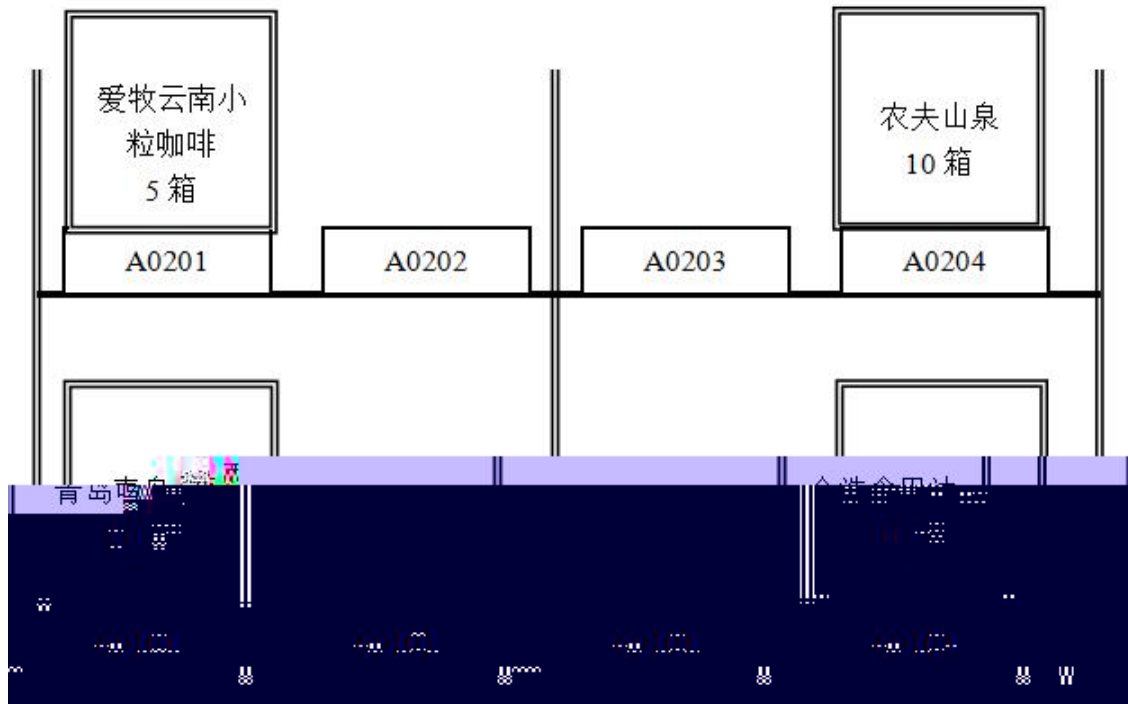

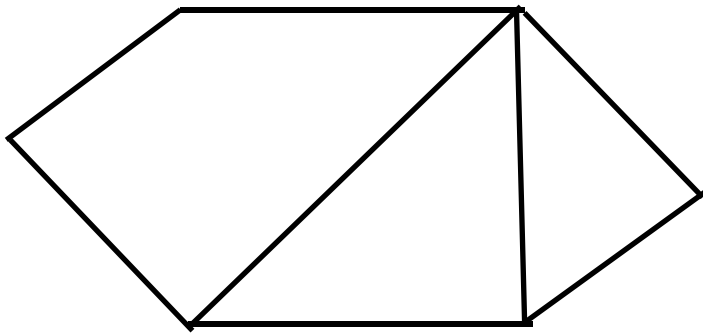

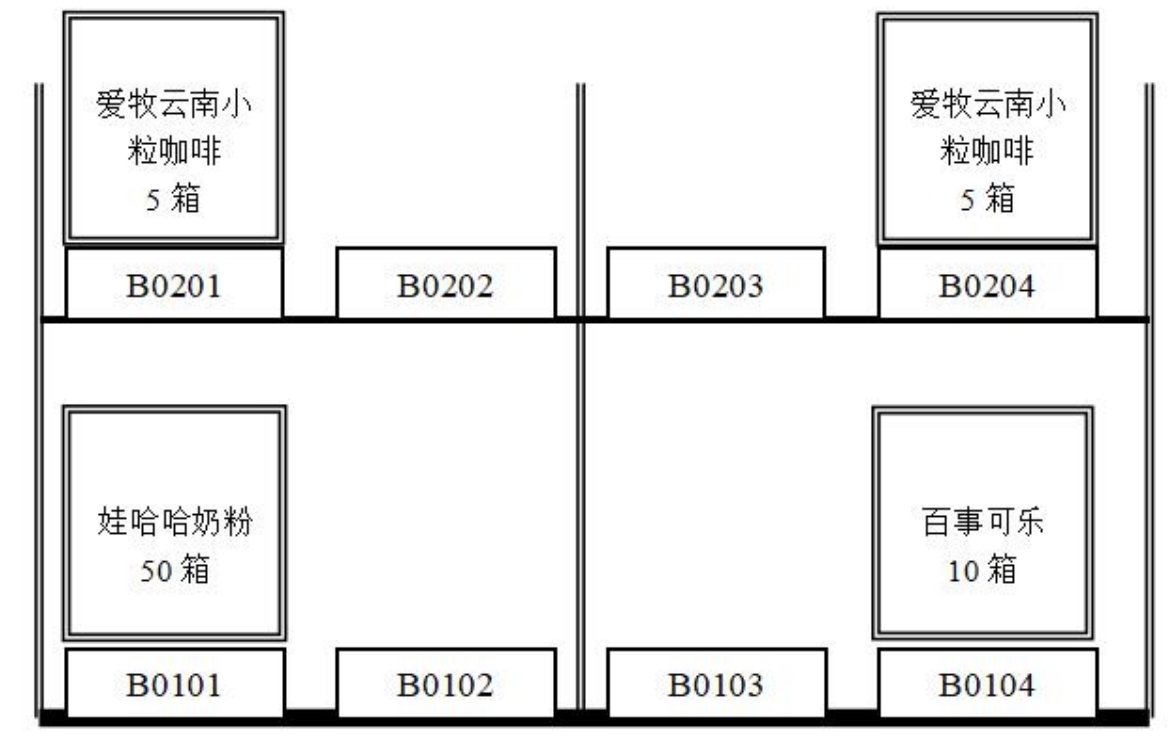
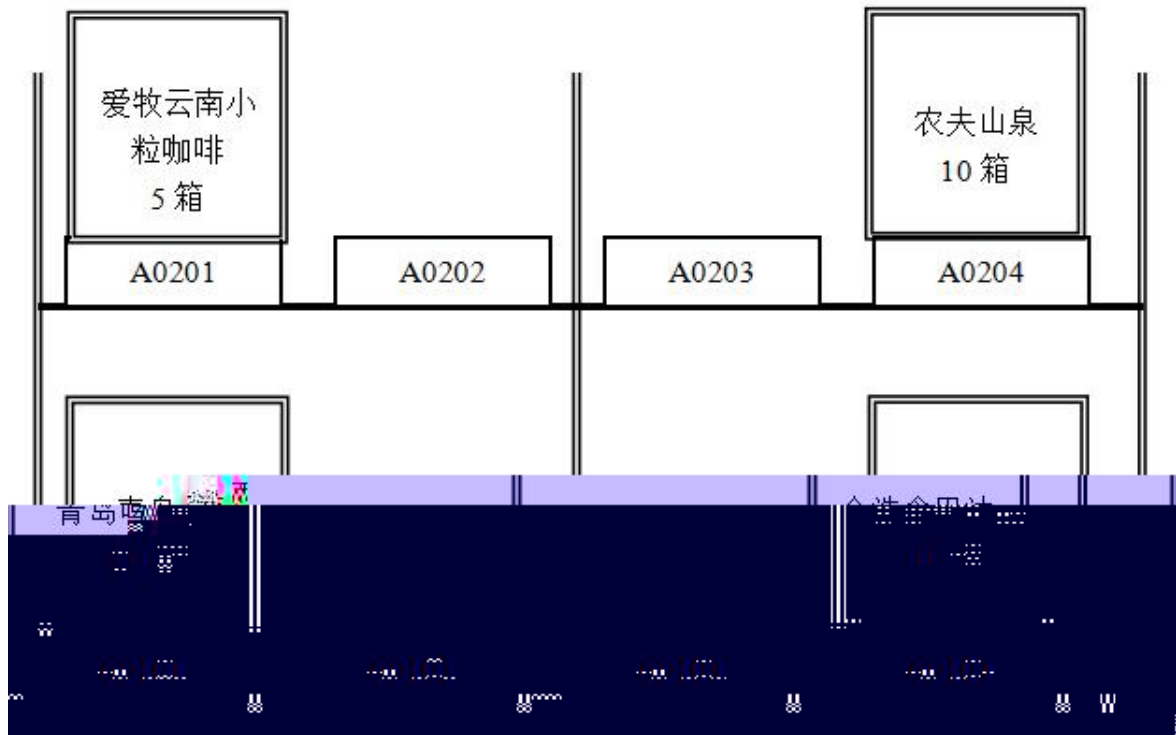



1

		---	---		

		---	---		

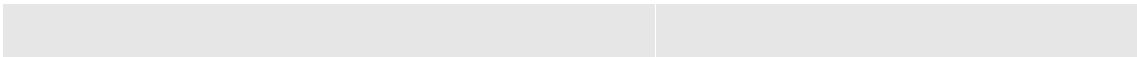

--- ---

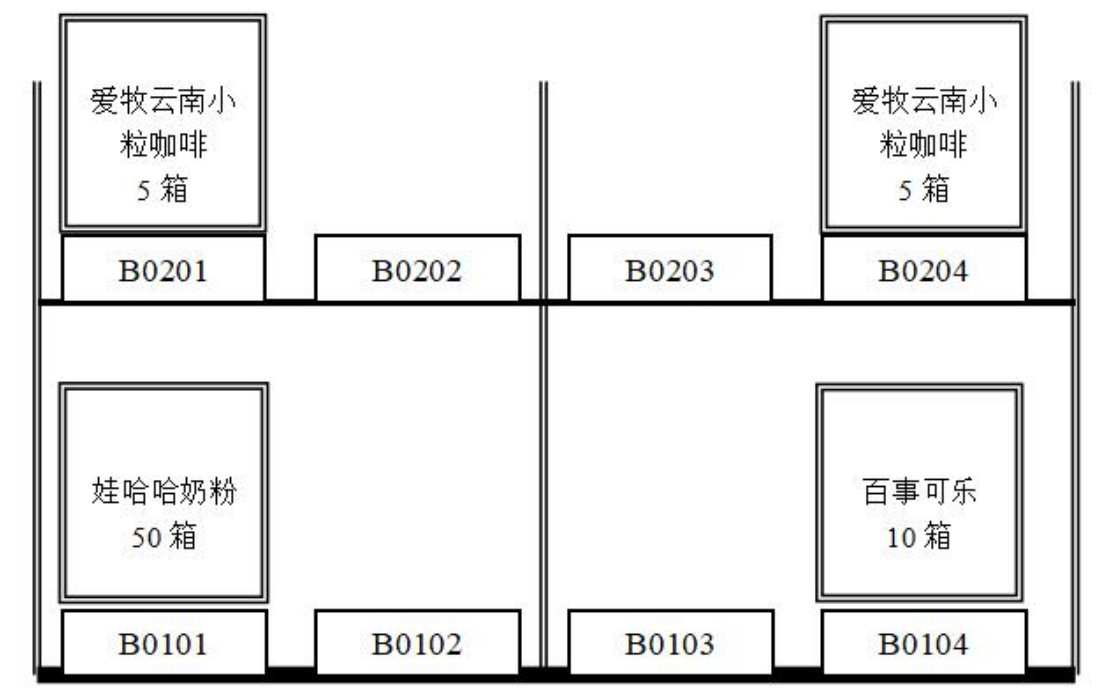
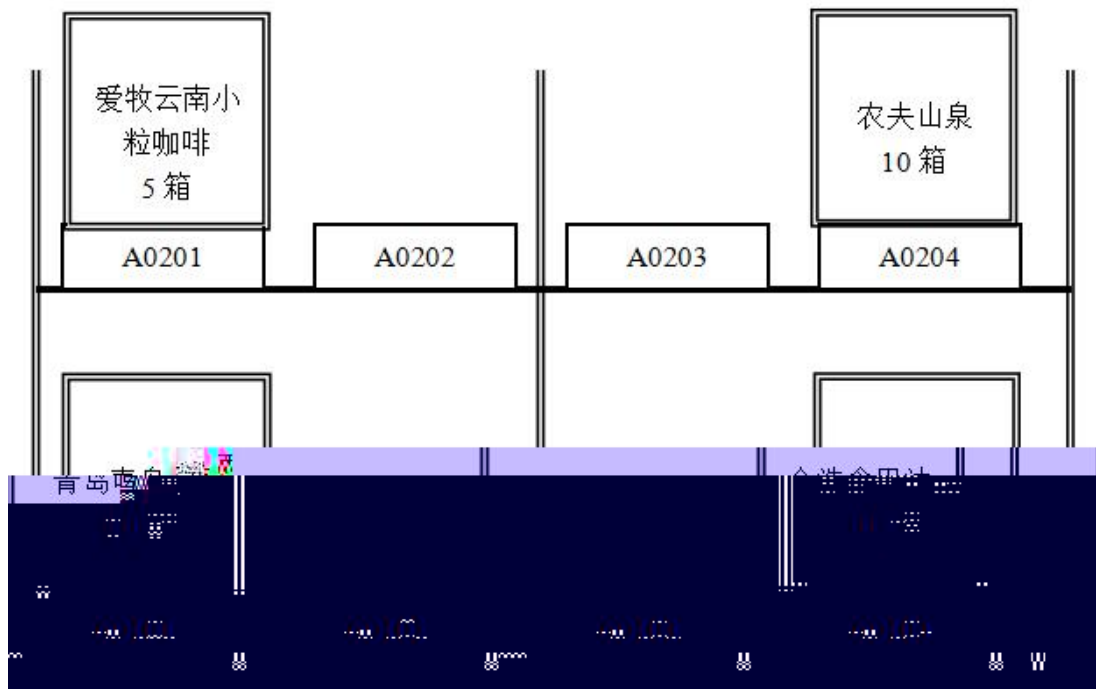

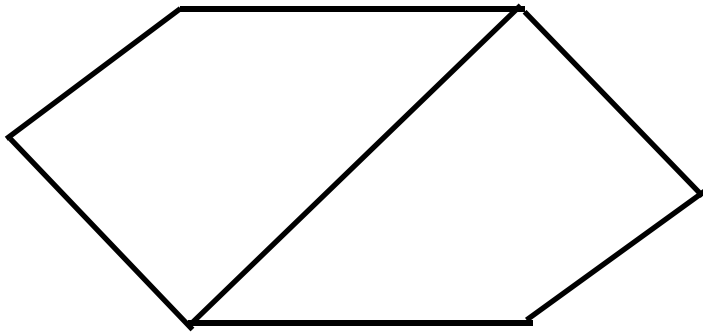

1

--	--	--	--	--	--

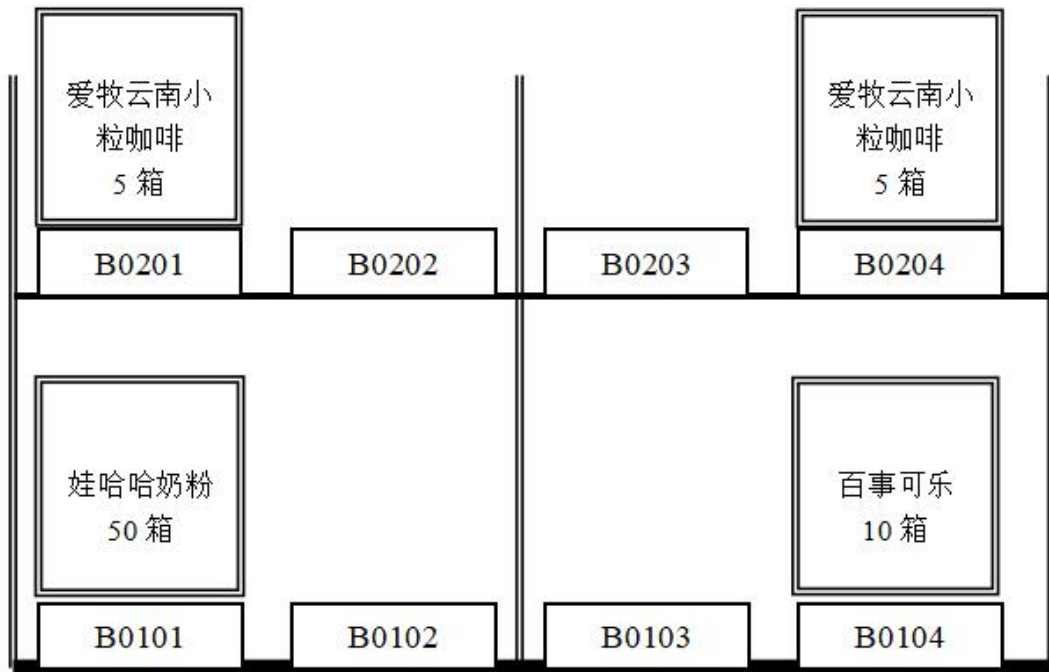
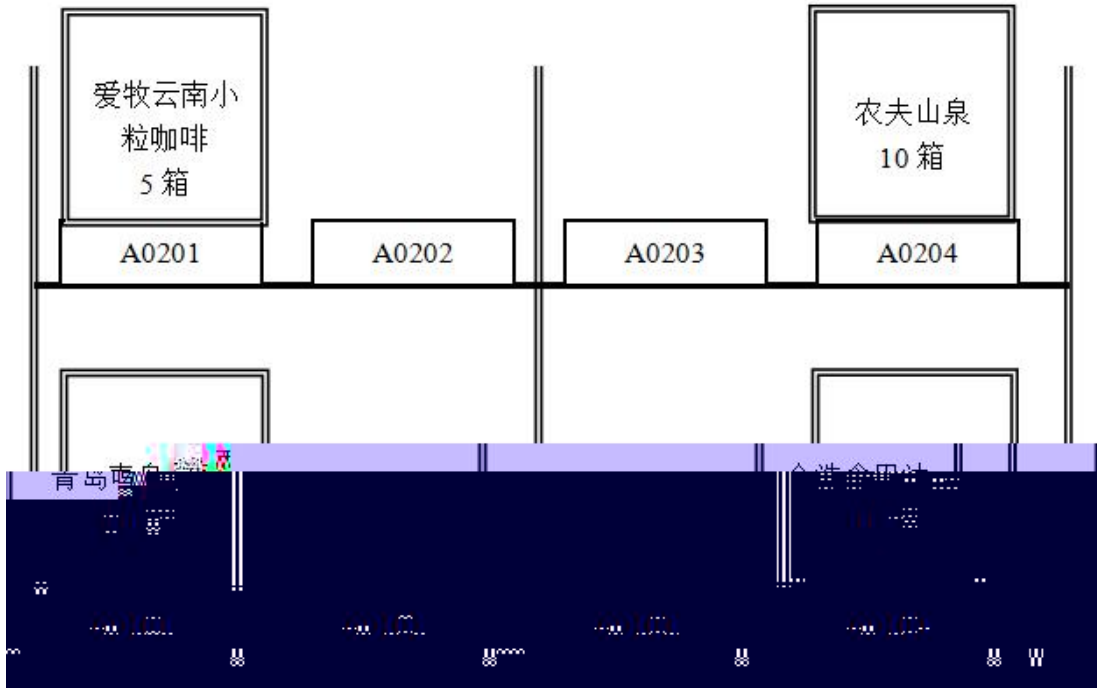

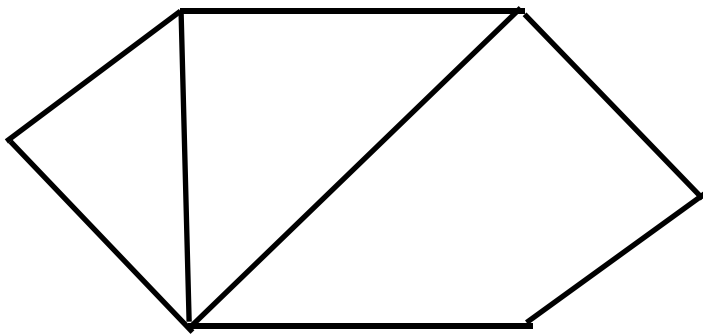

○

○

○

○

2

○

○

○

○

--	--

○

○

三、国际物流作业组织与管理模块

○



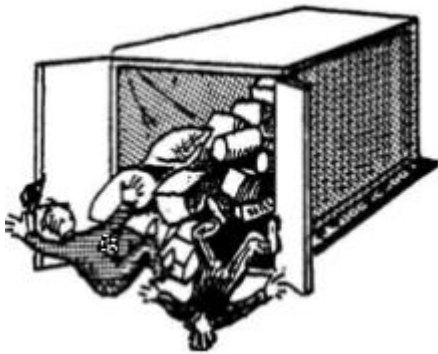
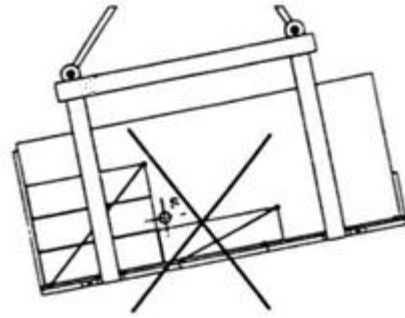

○

船公司	船名/航次	服务代码	航线	装船港/卸船港	启-达日期	天	挂港
Carrier	Voyage	Service	Lane	Load/Unload Port	ETD-ETA	Day	Port
MSC	MASTER		中国-香港	HONG KONG 香港	02/25 (二)	1	香港
地中海航运	74087			KAOHSIUNG 高雄	03/15 (一)	1	高雄
NYK	ITALIAN EXPRES		中国-香港	HONG KONG 香港	02/25 (二)	1	香港
日本邮船	E 024			BANGKOK 曼谷	03/02 (三)	6	曼谷
CMA-CCM	CMA CCM GEMINI		中国-非洲	XIAMEN 厦门	02/25 (二)	1	厦门
地中海航运	02AA49E			DURBAN 德班	03/27 (四)	30	德班
KLINE	HYUNDAI PLATINU		中国-中国	SHANGHAI 上海	02/25 (二)	1	上海
川崎汽船	M 004W			PANAGUA 巴拿马	04/09 (三)	43	巴拿马
EMS	COSCO KAOHSIUNG		中国-美国	HONG KONG 香港	02/25 (二)	1	香港
招商局	S/GFS46E			NOLMEA 努美阿	04/02 (三)	36	努美阿
RCL	ROTA PERMASAN		中国-中东/波斯湾/印度	QINGDAO 青岛	02/26 (三)	1	青岛
招商局	VPM114			MADRAS 马德拉斯	03/18 (二)	18	马德拉斯
ZIM	KUD HUNG	CHINA_VIETN AM (CYK)	中国-香港	NINGBO 宁波	02/25 (二)	1	宁波
招商局	311			HONG KONG 香港	03/15 (六)	18	香港
SAPMARINE	HEINE P		中国-非洲	KAOHSIUNG 高雄	02/25 (二)	1	高雄
招商局	1404			MINDELO	04/05 (六)	39	明德洛
CEAY	CAP SAN NICOLA		中国-中国	SHANGHAI 上海	02/25 (二)	1	上海
招商局	S 01409			RIO GRANDE 里奥格兰德	04/07 (一)	41	里奥格兰德
OOCL	DRESDEN EXPRES	Pacific Atl antic (PAX)	中国-美国	SHANGHAI 上海	02/25 (二)	1	上海
招商局	S 16608			HALIFAX 哈利法克斯	04/14 (一)	48	哈利法克斯

○
○

BEIJING	CN		BJ\$
Y. RENMINBI	CNY		KGS
BOSTON	US	M	630.00
		N	79.97
		45	60.16
		100	53.19
		300	45.80

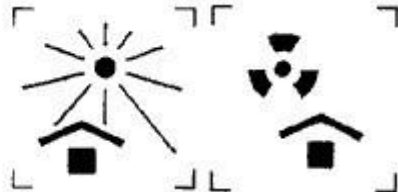

○

○

○

**集装箱设备交接单
EQUIPMENT INTERCHANGE RECEIPT**

OUT 出场

No.

用箱人/运箱人(CNTR. USER/HAULIER)			提箱地点(PLACE OF DELIVERY)		
发往地点(DELIVERED TO)			返回/收箱地点(PLACE OF RETURN)		
船名/航次(VESSEL/VOYAGE No.)		集装箱号(CNTR. No.)		尺寸/类型(SIZE/TYPE)	
提单号(B/L No.)		危险品类别(IMCO CLASS)		箱封号(SEAL No.)	
免费期限(FREE TIME PERIOD)		运输工具牌号(TRUCK WAGON BARGE No.)		承运人(CNTR. OPTR)	
货重(CARGO W.)		出场目的/状态(PPS OF GATE-OUT/STATUS)		进场目的/状态(PPS OF GATE-IN/STATUS)	
				出场日期(TIME-OUT)	
				月 日 时	
出场检查记录(INSPECTION AT THE TIME OF INTERCHANGE)					
普通集装箱(GP. CNTR.)		冷藏集装箱(REF. CNTR.)		特种集装箱(SPL. CNTR.)	
发电机(GEN. SET)					
<input type="checkbox"/> 正常(SOUND) <input type="checkbox"/> 异常(DEFFECTIVE)		<input type="checkbox"/> 正常(SOUND) <input type="checkbox"/> 异常(DEFFECTIVE)		<input type="checkbox"/> 正常(SOUND) <input type="checkbox"/> 异常(DEFFECTIVE)	
<input type="checkbox"/> 正常(SOUND) <input type="checkbox"/> 异常(DEFFECTIVE)		<input type="checkbox"/> 正常(SOUND) <input type="checkbox"/> 异常(DEFFECTIVE)		<input type="checkbox"/> 正常(SOUND) <input type="checkbox"/> 异常(DEFFECTIVE)	
损坏记录及代号(DAMAGE CODE)					



--	--	--	--	--	--

--	--	--

--	--	--	--	--	--

--	--	--	--	--	--

--	--	--	--	--	--	--	--

○

↙



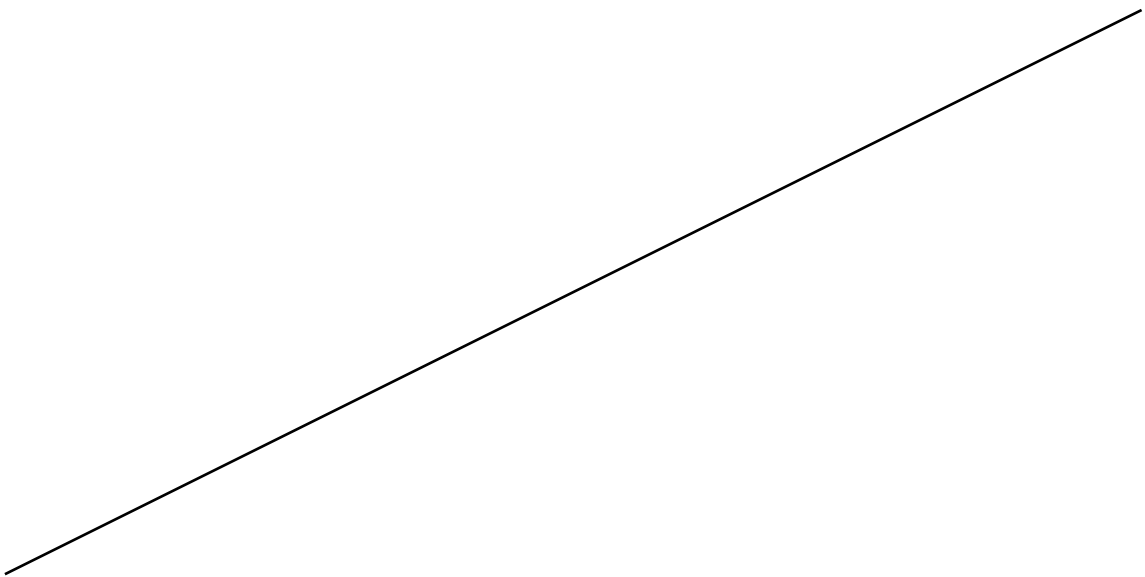

WORLD OF

WORLD OF

WORLD OF

○

--	--	--

--	--	--	--	--	--

○

○

○

○

四、 快递物流作业组织与管理模块

--	--	--	--	--	--

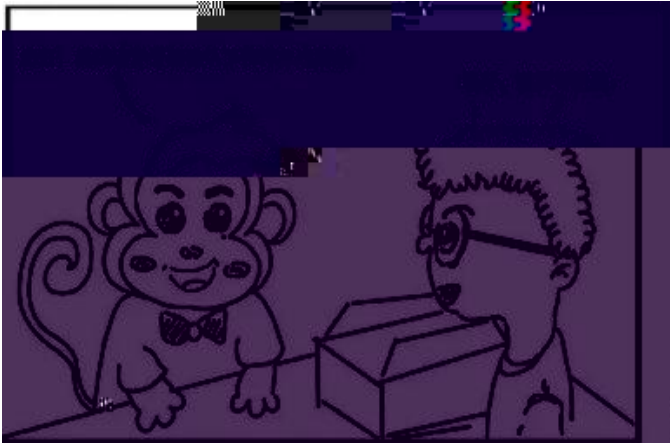

出示身份证件实名信息录入，确保信息安全



开箱验视，确保包裹中无违禁品

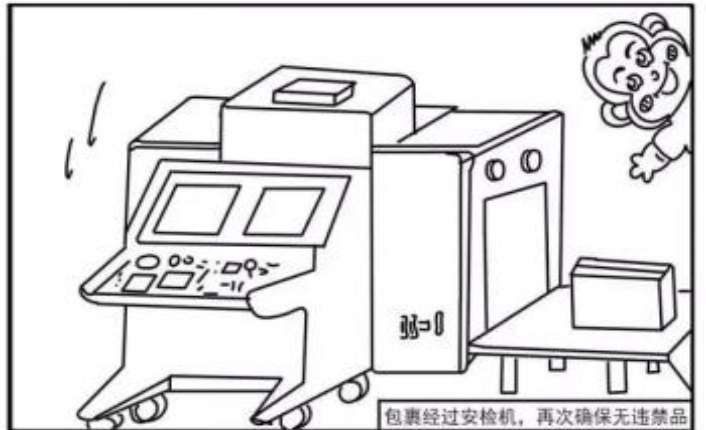

包裹经过安检机，再次确保无违禁品



您好，请麻烦出示下你的身份证

好的，已经好了



宅急送，致力于成为中国最有价值的综合物流服务商

--	--	--	--	--	--

--	--	--	--	--	--

[想知道:中国成都理工大学校园快递具体在哪? 百度知道](#)

3个回答 - 提问时间: 2014年02月10日

最佳答案  均在银杏后面。宝盒、圆通、顺丰在电影院后面。中通、申通在图书馆下面。常用的是这几个。

zhidao.baidu.com/link?... 2014-02-15 - 百度快照 - 80%好评

--	--	--	--

--	--	--	--

<hr/>
